



ASHWORTH ENGINEERING

Committed to on-time delivery of defect-free products and services, fit for use, exactly as promised, every time.



PRODUCT TECHNICAL BULLETIN

OMNI-GRID[®] & OMNI-LITE[®]

Turn Curve belting consisting of assembly of links and rods capable of accommodating turns in a conveyor system. Mesh overlays are available to give greater product support.

TABLE OF CONTENTS	Page
Defining Characteristics	1
Belt Specifications	1
Belt Weight	2
Belt Options	2
Sprockets	4
Wear Strip Placement	5
Engineering Calculations	5
System Requirements	6

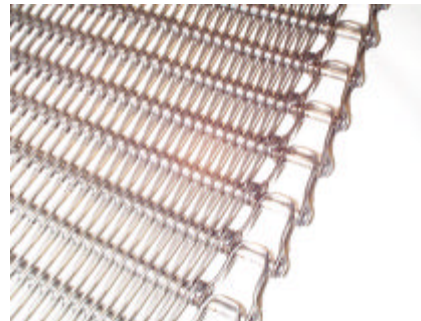

DEFINING CHARACTERISTICS

- Turn Capability:** Turns both left and right
- Mode of Turning:** Inside edge collapses in turn
- Minimum Turn Ratio:** 2.2:1 or greater
- Width Limits:** 6 inches [152 mm] to 40 inches [1016 mm] for turn curve applications
- Maximum Allowable Tension through a turn:** 100 lbs. Standard Links; 150 lbs. Heavy Duty Links
- Longitudinal Pitch:** 1 inch Pitch = 1.08 inches [27.5 mm]; 3/4 inch Pitch = .75 inches [19.0 mm]
- Method of Drive:** Sprocket driven on links
- Material:** Stainless Steel

BW = Overall Belt Width

Conveying Surface:	Standard links	Heavy duty links
1" Pitch:	BW - 2.21 in [56.2 mm]	BW - 2.49 in. [63.4 mm]
3/4" Pitch:	BW - 2.22 in. [56.5 mm]	BW - 2.44 in. [62.1 mm]

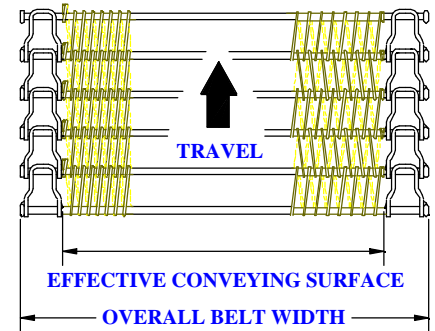

BELT SPECIFICATIONS

'Wear Resistant' Feature:

- ◆ Standard on all tension bearing links.
- ◆ Increases belt life by reducing belt elongation.

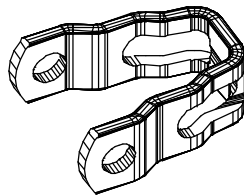

Short-slotted Links:

- ◆ Recommended for use on over-sized turns when turn ratio exceeds 2.5 to 1.
- ◆ Minimizes 'belt chatter' and product movement on oversized turns.
- ◆ Used on inside or outside belt edge or both.

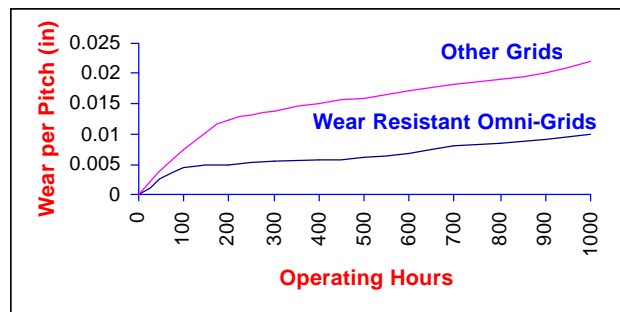

** Note that heavy-duty links are non-collapsing only for 3/4 inch Pitch. Therefore, if heavy-duty links are required and must be on outside edge only, belt is then uni-directional.*

BELT WEIGHT

OMNI-GRID BELT DATA								
BELT WIDTH		TURN RADIUS		¾ Inch Pitch		1 Inch (1.08) Pitch		Calculating total belt weight: Belt Weight = (Weight of Base Belt) + (Weight of Mesh Overlay)
in.	mm	in.	mm	lbs/ft	kgs/m	lbs/ft	kgs/m	
6	152	13.2	335	1.37	2.0	1.30	1.9	Steps of Calculation: <ul style="list-style-type: none"> Determine weight of base belt in lbs./foot or kgs./meter from accompanying table. Calculate conveying surface and convert to units of feet or meters. Use the conveying surface and mesh type to determine weight of mesh in lbs./foot or kgs./meter. Add weight of base belt to weight of mesh overlay, lbs./foot or kgs./meter. Multiply calculated value by belt length (feet or meters) for total belt weight in units of lbs. or kgs.
8	203	17.6	447	1.64	2.4	1.48	2.2	
10	254	22.0	559	1.91	2.8	1.66	2.5	
12	305	26.4	671	2.18	3.3	1.84	2.7	
14	356	30.8	782	2.45	3.7	2.02	3.0	
16	406	35.2	894	2.72	4.1	2.20	3.3	
18	457	39.6	1006	2.99	4.5	2.38	3.5	
20	508	44.0	1118	3.26	4.9	2.56	3.8	
22	559	48.4	1229	3.53	5.3	2.74	4.1	
24	610	52.8	1341	3.80	5.7	2.92	4.4	
26	660	57.2	1453	4.07	6.1	3.10	4.6	
28	711	61.6	1565	4.34	6.5	3.28	4.9	
30	762	66.0	1676	4.61	6.9	3.46	5.2	
32	813	70.4	1788	4.88	7.3	3.64	5.4	
34	864	74.8	1900	5.15	7.7	3.82	5.7	
36	914	79.2	2012	5.42	8.1	4.00	6.0	
38	965	83.6	2123	5.69	8.5	4.18	6.2	
40	102	88.0	2235	5.96	8.9	4.36	6.5	

¾ Inch Pitch Omni-Grid Overlay Weights

Mesh Lateral Count	18 ga .0475 in. [1.2 mm]		17 ga .054 in. [1.4 mm]		16 ga .0625 in. [1.6 mm]		14 ga .080 in. [2.0 mm]	
	lbs/ft²	kgs/m²	lbs/ft²	kgs/m²	lbs/ft²	kgs/m²	lbs/ft²	kgs/m²
12	.25	1.2	.33	1.66	.44	2.2	0.75	3.7
18	.36	1.8	.48	2.3	.63	3.1	1.08	5.3
24	.47	2.3	.62	3.0	.83	4.1	1.41	6.9
30	.58	2.8	.77	3.8	1.03	5.0	1.75	8.6
36	.69	3.4	.92	4.5	1.23	6.0	2.09	10.2
42	.81	4.0	1.07	5.2	1.43	7.0	2.44	11.9
48	.92	4.5	1.22	6.0	1.63	8.0	2.78	13.6
60	1.15	5.6	1.53	7.5	2.03	9.9	3.46	16.9

1 Inch Pitch Omni-Grid Overlay Weights

Mesh Lateral Count	18 ga .0475 in. [1.2 mm]		17 ga .054 in. [1.4 mm]		16 ga .0625 in. [1.6 mm]		14 ga .080 in. [2.0 mm]	
	lbs/ft²	kgs/m²	lbs/ft²	kgs/m²	lbs/ft²	kgs/m²	lbs/ft²	kgs/m²
12	.22	1.1	.29	1.4	.38	1.9	.64	3.1
18	.31	1.5	.42	2.1	.55	2.7	.94	4.6
24	.41	2.0	.56	2.7	.74	3.6	1.23	6.0
30	.51	2.5	.68	3.3	.93	4.5	1.54	7.5
36	.61	3.0	.82	4.0	1.08	5.3	1.84	9.0
42	.71	3.5	.95	4.6	1.26	6.2	2.14	10.5
48	.82	4.0	1.08	5.3	1.44	7.0	2.44	11.9
60	1.02	5.0	1.35	6.6	1.80	8.8	3.05	14.9

BELT OPTIONS

DESIGNATION

B X-Y-Z and U X-Y-Z
First Digit: B = Balanced Weave; U = Unilateral Weave
X: First Number: No. of Loops per Foot of Width
Y: Second Number(s): No. of Spirals per Foot of Length (12 for 1 in. pitch, 16 for ¾ in. pitch)
Z: Third Number: Wire Gauge
Examples:
 B30-16-17 (¾ Inch Pitch Omni-Grid)
 U42-12-16 (1 Inch Pitch Omni-Grid)

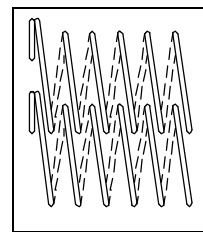

Unilateral Weave

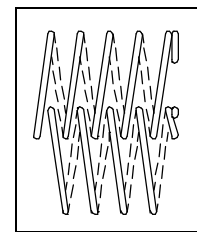

Balanced Weave

Sizes: 14 through 18 ga. (.080 in. [2.0 mm]) through .048 in. [1.2 mm] diameter)
Materials: annealed or high tensile spring wire (Omni-Tough®)

WIRE MESH OVERLAYS

Variable Loop Count

(Patent No. 6,129,205)

- When belt collapses on inside edge to accommodate a turn, product support is maximized and wire overlay does not overlap.
- Mesh count is more open on the inside belt edge and progressively gets tighter across the width of the belt.
- Available in Omni-Tough® only
- Turn direction must be specified.
- Mesh designated as follows: B42/24-12-17 where belt has an inside mesh of 24 progressing to 42 spirals/foot.

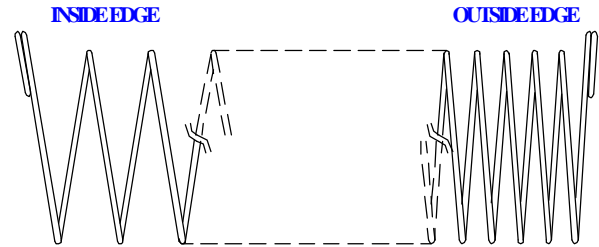

Omni-Tough® (For more information reference Technical Product Bulletin “063 Omni-Tough”)

- Provides a flatter mesh surface with a high resilience to impact.
- Available for most belt widths in most mesh configurations. Available in 16 and 17 ga. only.

Special Spirals:

- Available in Omni-Tough® only
- One or more spirals on conveying surface is raised
- Used as guard edges, lane dividers and flights
- Maximum height equal to belt pitch
- Available Options: height, spacing, location, shape, number of lanes in belt.

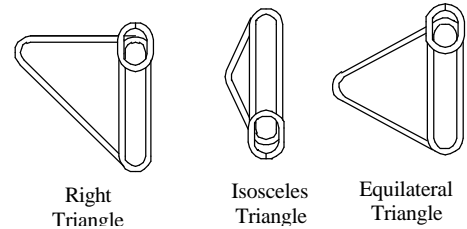

Right
Triangle

Isosceles
Triangle

Equilateral
Triangle

PLASTIC OVERLAY

OMNI-LITE®

Omni-Lite is a plastic overlay attachment that can be used in place of wire mesh overlay and is for use with our 1" pitch Heavy Duty Omni-Grid belts.

Weight:

Omni-Lite overlay adds .7 pounds per square foot (3.42 kg/m²) to the basic weight of the Omni-Grid belt.

Method of Drive:

Sprocket driven on both links.

Construction:

Omni-Lite is molded of an FDA approved High Density Polyethylene (HDPE) that is attached to an Omni-Grid belt by snapping it on over the rods while in the collapsed position. When the belt is expanded, the overlay is captured and can not be removed. Should a section of overlay become damaged it can be removed and easily replaced. All belts using the Omni-Lite overlay are constructed using heavy-duty links.

Available Belt Widths:

Belts that are to be used in turning applications can be manufactured in widths from 8-1/2" (203.2 mm) to 39" (990.6 mm). If the belt is to be used in a straight run only application widths up to 60" (1524 mm) are available. Due to the 3/4" (19.1 mm) lateral pitch of the module, only certain mesh widths will offer a good fit between the links. Contact Ashworth engineering.

Conveying Surface: = about two inches less than the overall belt width.

Turning Radius:

The minimum inside turning radius is 2.2 times the belt width. Turning radii larger than 2.2 times the belt width are acceptable, but may require special modified links.

NOTE: This belt is able to turn either right or left, however, special limitations apply when considering an "S" type turn, contact Ashworth engineering.

Belt Strength:

Maximum operating tension is 150 lbs. [667 Newton's] entering and exiting a turn, 300 lbs. [1334 Newton's] in straight run applications.

Driven By:

Omni-Lite is driven by sprockets, as is our standard Omni-Grid.

Temperature Range:

-100 °F (-73.3 °C) to +180 °F (82.2 °C).

Steam is not known to be detrimental to the overlay if it does not exceed the given temperature limits.

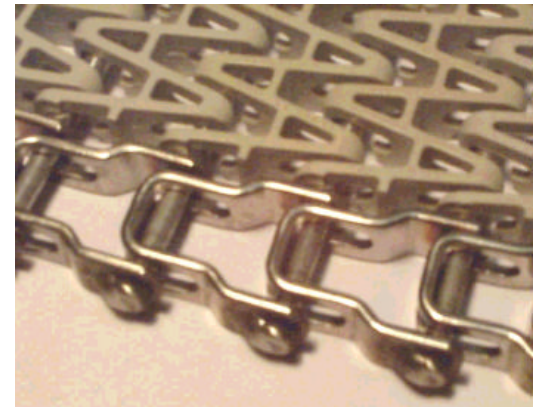

1" Pitch Omni-Grid with Omni-Lite overlay
Open area 42%, straight runs; 34% in turns
Material: (HDPE) high-density polyethylene

GUARD EDGES

Integral Guard Edge Link

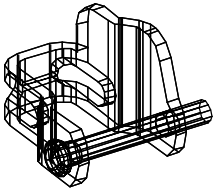

Inside edge of link raised to prevent product from falling off belt edge.
 Offers improved cleanup and sanitation over guard edge plates.
 Available in various heights from 1/2 inch [12.7 mm] to 2 inches [50.8 mm] above the belt surface.
 Rod spacing and whether one or both sides of the belt as specified.
 Stainless Steel.
 Heavy Duty Links only.

Guard Edge Plates

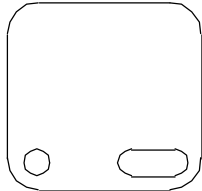

- Plates assembled onto belt edges between links and mesh to prevent product from falling off belt edge.
- Available in various heights from 1/2 inch [12.7 mm] to 1-1/2 inches [38.1 mm] above the belt surface.
- Rod spacing and whether one or both sides of the belt as specified.
- Stainless Steel and T316 Stainless Steel.

SPROCKETS

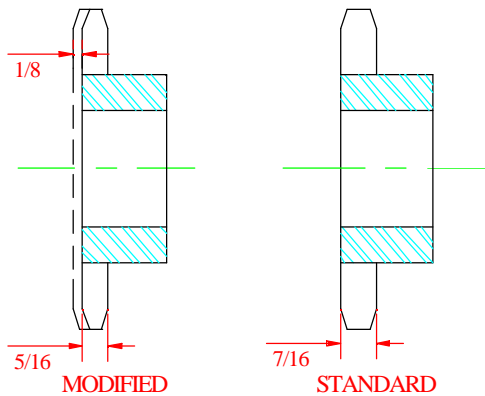

18 TOOTH UHMW PE SPROCKET

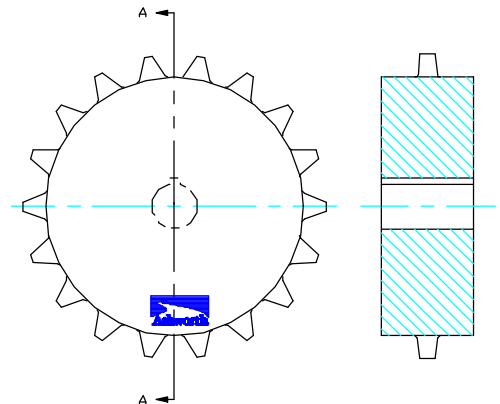

Note: 3/4 Inch Pitch Omni-Grid can use #60 roller chain sprockets modified as follows:

1. Face off sprocket such that the overall tooth width is 5/16 inch [7.94 mm].
2. Chamfer corners of the newly machined teeth.

Steel sprockets for 3/4 inch pitch belts.

No. of Teeth	Overall Diameter		Pitch Diameter		Flange Diameter		Flange Width		Hub Width		Hub Diameter		Bore			
	inch	mm	inch	mm	inch	mm	inch	mm	inch	mm	inch	mm	Minimum	inch	Maximum*	Mm
12 ^{1*}	3.40	86.4	2.90	73.6	--	--	--	--	1.00	25.4	2.25	57.2	1.00	25.4	1.44	36.5
12 ^{2*}	3.40	86.4	2.90	73.6	--	--	--	--	1.00	25.4	2.25	57.2	1.00	25.4	1.44	36.5

*Material: 12¹-T = T303 stainless steel, 12²-T = C1141 hardened steel

NOTES:

- UHMWPE material type components have a 150°F [66°C] maximum operating temperature.
- Maximum bore sizes listed for UHMWPE material is based on 1/2 inch [12.7 mm] of material above keyway.

Standard UHMW sprockets for 1.08 inch pitch belts.

No. of Teeth	Overall Diameter		Pitch Diameter		Flange Diameter		Flange Width		Hub Width		Hub Diameter		Bore			
	inch	mm	inch	mm	inch	mm	inch	mm	inch	mm	inch	mm	Minimum	inch	Maximum*	Mm
9	3.53	89.7	3.16	80.2	--	--	--	--	2.00	51.0	2.53	64.3	.813	20.6	1.44	36.5
13	4.90	124.5	4.53	115.1	--	--	--	--	2.00	50.8	3.90	99.1	1.00	25.4	2.19	55.6
18	6.65	168.9	6.24	158.5	--	--	--	--	2.00	50.8	5.65	143.5	1.00	25.4	3.75	95.3
23	8.39	213.0	7.96	202.2	--	--	--	--	2.00	50.8	7.39	187.6	1.00	25.4	4.00	101.6
31	11.16	283.5	10.72	272.3	--	--	--	--	2.00	50.8	101.6	258.1	1.00	25.4	7.13	183.0
37	13.24	336.2	12.73	323.5	--	--	--	--	2.00	50.8	12.24	310.8	1.00	25.4	8.94	277.0

Steel sprockets for 1.08 inch pitch belts.

No. of Teeth	Overall Diameter		Pitch Diameter		Flange Diameter		Flange Width		Hub Width		Hub Diameter		Bore			
	inch	mm	inch	mm	inch	mm	inch	mm	inch	mm	inch	mm	inch	Mm		
13	4.80	124.5	4.53	115.1	--	--	--	--	2.00	51.0	3.90	99.1	1.00	25.4	2.19	55.6

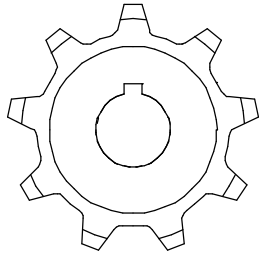

#3, 9 TOOTH
3/4 inch Pitch Omni-Grid

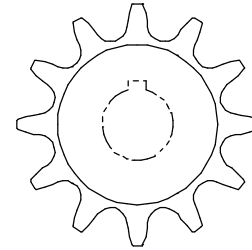

#3, 12 TOOTH
3/4 inch Pitch Omni-Grid

SUPPORT

Supports are required on a maximum of 6 inches apart on load side and 12 inches maximum on return side. Rollers may also be used.

NOTE: For heavier load applications, additional sprockets and/or idlers may be required.

WEARSTRIP PLACEMENT

$A = \frac{1}{2} \times PD - \text{Belt Thickness}$

- This is only a guideline; it does not take into account the influence of speed.
- At speeds above 75 ft/min [23 m/min] Ashworth recommends increasing the distance A and shortening the wear strips as much as one belt pitch in length. (Nominal Belt Pitch: for 1 inch pitch = 1.08 inches [27.5 mm]; for 3/4 inch pitch = .75 inches [19.0 mm]) Belt Thickness = for 3/4 inch pitch is .4375 [11.1mm]; for 1 inch pitch is .50 [12.7mm].

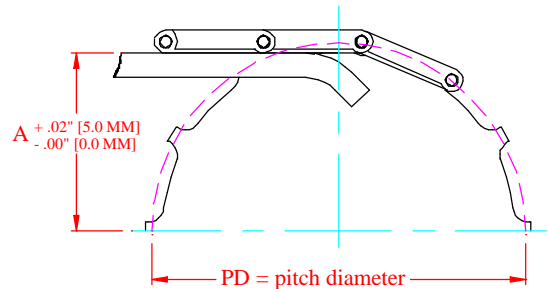

ENGINEERING CALCULATIONS

COEFFICIENT OF FRICTION	
Coefficient of Friction	Type of Support Structure
.15	Nylon-12 under overlay (unlubricated)
.15	Acetal under overlay (unlubricated)
.10	Acetal under overlay (lubricated)
.15	Steel support rails (lubricated)
.20	Steel support rails (unlubricated)
.20	UHMW under links (unlubricated)

TURN RATIO

$TR = ITR \div BW$

where ITR = Inside Turn Radius
BW = Belt Width

Turn Ratio is dimensionless. Inside Turn Radius and Belt Width must both be in same unit of measurement, either both in units of inches or both in units of millimeters.

Belt Type	Tension Link	Turn Radius to Tension Link
3/4 inch Pitch Omni-Grid	Outside Link	ITR + Belt Width
1 inch Pitch Omni-Grid	Outside Link	ITR + Belt Width



BELT WEIGHT

Belt Weight = (Weight of Base Belt) + (Weight of Mesh Overlay)

STEPS OF CALCULATION:

- ◆ Determine weight of base belt in lbs./feet or kgs/meter.
- ◆ Calculate conveying surface and convert to units of feet or meters.
- ◆ Use the conveying surface and mesh type to determine weight of mesh in lbs./feet or kgs/meter.
- ◆ Add weight of base belt to weight of mesh overlay, lbs./feet or kgs/meter
- ◆ Multiply calculated value by belt length (feet or meters) for total belt weight in units of lbs. or kgs.

BELT TENSION

Estimated belt tension in a straight run:

$$T = (wLfr + WLf_1 + WH) \times C$$

Where T = Belt Tension (lbs. force/linear ft of belt width) [*newtons*]
 W = Belt Weight (lbs./linear ft.) [*kg/linear meter*]
 W = Total Weight = Belt Weight + Product Weight (lbs./linear ft) [*kg/linear meter*]
 L = Conveyor Length or center to center of terminals (feet) [*meters*]
 H = Rise of incline Conveyor {+ if incline, - if decline} (feet) [*meters*]
 f₁ = Coefficient of Friction between belt and belt supports, load side *dimensionless*
 f_r = Coefficient of Friction between belt and belt supports, return side *dimensionless*
 C = Force Conversion Factor
 Imperial: 1.0
 Metric: 9.8

SYSTEM REQUIREMENTS**OMNI-GRID with OMNI-LITE OVERLAY****Support**

Nylon 12 is the suggested belt support material for use under the Omni-Lite overlay.

Other options are:

Stainless steel -- Must be a minimum width of 1/2" (12.7 mm) - wider widths up to 1" (25.4 mm) would be better.

Must have no protrusion or burrs.

To be polished with a minimum surface finish of 1.6 μm.

To be cold rolled with a hardness of 25-30 HRC

Must have radii on all edges of at least 1/8" (3.2 mm).

Not to be used under the links.

Acetal -- Non acid washer applications. Material to be pure, the use of recycled (regrind) Acetal is not recommended.

UHMW Polyethylene -- Should be used as wear strips under the links, but not under the overlay.

USDA Acceptance:

OMNI-LITE/OMNI-GRID is listed in the USDA ACCEPTED MEAT AND POULTRY EQUIPMENT list of acceptable equipment.

Products:

Fish, dough and other soft products that require maximum product support.

Problems: Heavily marinated products may become caught in overlay when used in freezing applications.

All applications using solvents should be cleared by engineering first.

Lubrication:

Lubrication with silicone may be necessary on the belt support rails in some cases. The best method of application is by brush, fed from a drip reservoir, brushed onto the bottom in the return so that the belt applies the lubricant to the rails on the load side. Apply lubricant until the take-up rises or the drive amp reading drops to set values determined by testing.

Typically, a customer uses 8 ounces per week on a system employing 1500 feet of belt in a 24 hour a day operation. As you can see, this is a very small amount of oil and dripping should not be a problem.

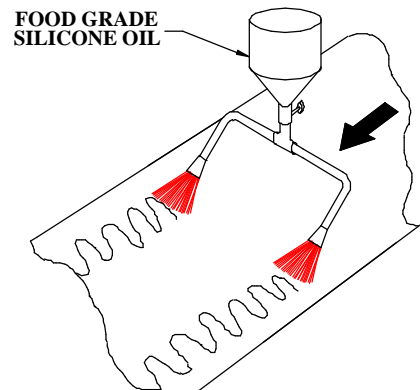
**POSSIBLE SYSTEM TENSION INDICATORS**

1. DRIVE MOTOR AMP. READING
2. TAKE-UP ROLL POSITION
3. DIRECT MEASUREMENT

SWING WIDE

The belt tends to "swing wide" as it exits the spiral cage or turn curve, following a path that is offset but parallel to the normal tangent line to the cage. This phenomena itself does no damage, but often the belt edge contacts framework that does not leave sufficient clearance for this to occur. The usual reaction of the builders or users is to restrict the path of the belt from swinging wide, typically by use of rollers or shoe guides.

Restraining the belt path can have several adverse effects on belt life:

- ◆ The belt can wear through a shoe guide, allowing the edge to snag. This will eventually cause an increase in belt tension and damage the belt edge.
- ◆ Outside edge restraints can push individual rods inward. The rods can be held in this inward position by belt tension. There is then a potential for the projecting rods to catch on the vertical cage bar capping, causing damage to the belt, damage to the cage bar capping, and high belt tension. If the belt is pushed into a straight tangent path, the tension carried in the outside edge of the belt is shifted to the inside edge of the belt, resulting in a pronounced tendency for one edge of the belt to lead the other.

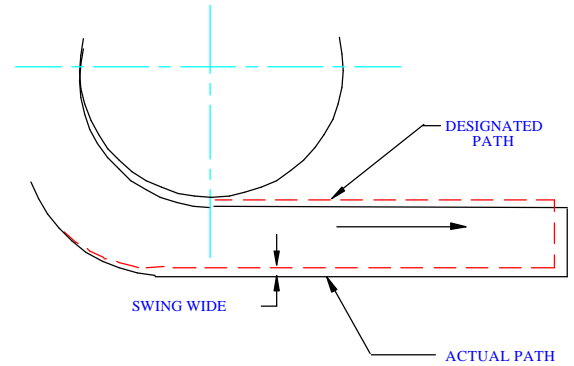
**FOR MORE INFORMATION ON Omni-Grid® OR OTHER ASHWORTH PRODUCTS –**

- ❑ See other Ashworth Technical Bulletins for conveyor design, lotension spiral applications, belt cleaning and other information.

– OR –

- ❑ Consult our Product Engineers for other options specific for your application and system design.

Reference: Product Technical Bulletin “Conveyor Design Guidelines”.

Copyright © Ashworth Bros., Inc. - All rights reserved. This document may not be reproduced in whole or in part without the express written consent of Ashworth Bros., Inc.

Ashworth Bros., Inc. provides this information only as a service to our customers and does not warrant the accuracy or applicability of the information contained herein.

Ashworth Jonge Poerink bv
Borne, The Netherlands
Tel: +31-74-265-6565
Fax: +31-74-266-1134
Email: ashworth@ashworth.nl

Ashworth Bros., Inc.
Winchester, VA U.S.A.
Phone: 540-662-3494
Fax: 800-532-1730
Email: ashworth@ashworth.com
Website: www.ashworth.com

Ashworth Europe Ltd.
Kingswinford, United Kingdom
Tel: +44-1384-355000
Fax: +44-1384-355001
Email: ashworth.europe@ukgateway.net