

Ø.192 [4.88]
ROD

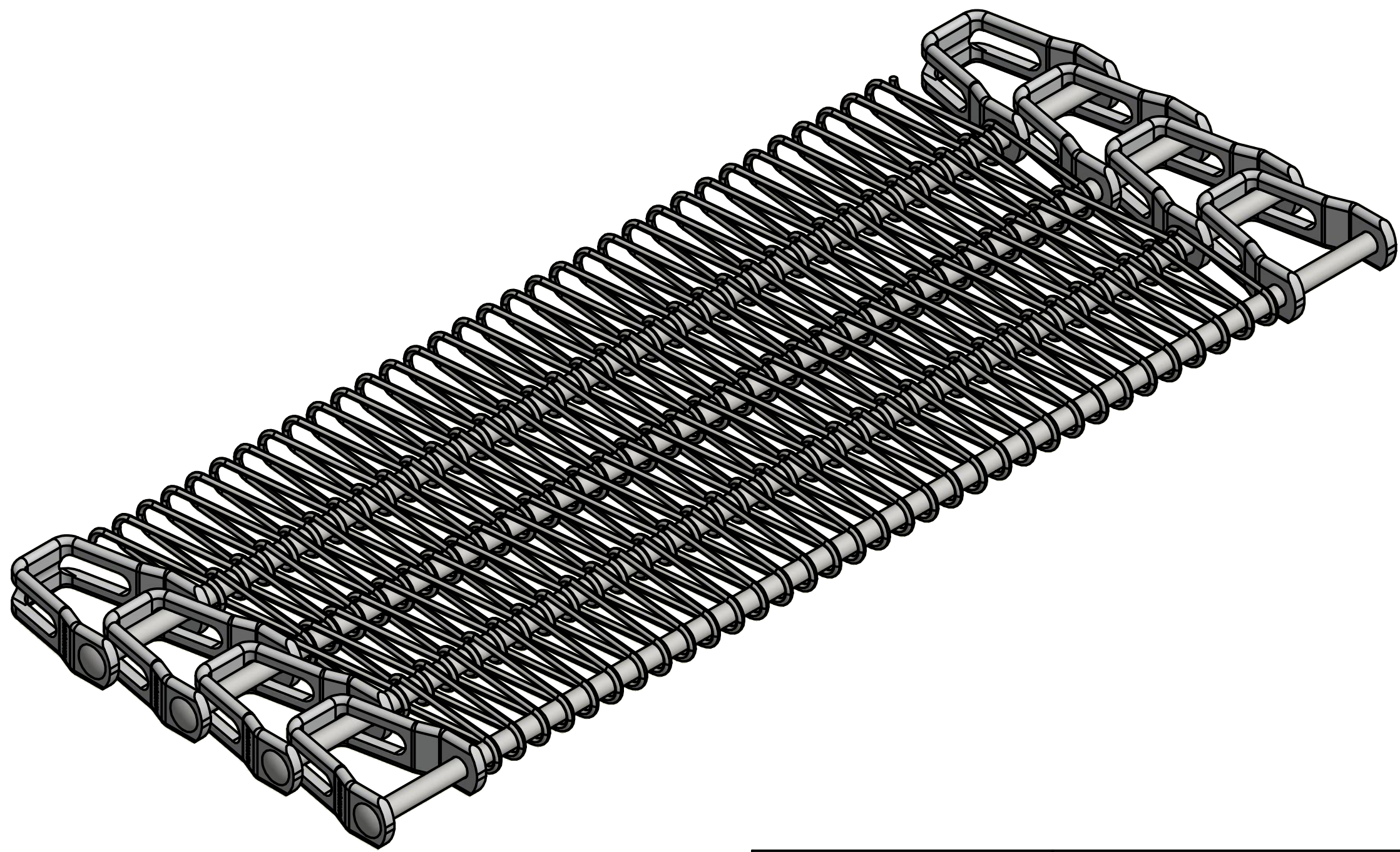

1.080 [27.43]
BELT PITCH

DO NOT SCALE DRAWING		 Ashworth Bros., Inc. 450 ARMOUR DALE, WINCHESTER, VA 22601
APPROVALS	DATE	
DRAWN	7/8/16	TITLE
UNLESS OTHERWISE SPECIFIED DIMENSIONS ARE IN INCHES. TOLERANCES: .X = ± .03 FRACTION ± 1/16 .XX = ± .015 ANGLES ± 1/2° .XXX = ± .005 .XXXX = ± .0005 SURF FINISH 63 ✓		ILLUSTRATION OG360-100 B42-12-16
CAD/FILE NAME		SIZE
OP Assembly.idw		B
SCALE		DWG. NO.
1/1		REV.
CALC.WT		SHEET
N/A		1 OF 2



VIEW5
SCALE 1/1

DO NOT SCALE DRAWING		 Ashworth Bros., Inc. <small>450 ARMOUR DALE, WINCHESTER, VA 22601</small>
APPROVALS	DATE	
DRAWN	7/8/16	TITLE
UNLESS OTHERWISE SPECIFIED DIMENSIONS ARE IN INCHES. TOLERANCES: .X = ± .03 FRACTION ± 1/16 .XX = ± .015 ANGLES ± 1/2° .XXX = ± .005 .XXXX = ± .0005 SURF FINISH 63 ✓		ILLUSTRATION OG360-100 B42-12-16
CAD/FILE NAME		SIZE
OP Assembly.idw		B
SCALE		DWG. NO.
1/1		REV.
CALC.WT		SHEET
N/A		2 OF 2