

Ø.236 [5.99]
ROD

.667 [16.93]
Mesh Pitch

1.500 [38.10]
BELT PITCH

DO NOT SCALE DRAWING		 Ashworth Bros., Inc. <small>450 ARMOUR DALE, WINCHESTER, VA 22601</small>	
APPROVALS	DATE	TITLE	
DRAWN	7/8/16	ILLUSTRATION OG360-150 B18-8-16	
UNLESS OTHERWISE SPECIFIED DIMENSIONS ARE IN INCHES. TOLERANCES: .X = ± .03 FRACTION ± 1/16 .XX = ± .015 ANGLES ± 1/2° .XXX = ± .005 .XXXX = ± .0005 SURF FINISH 63 ✓		SIZE	REV.
CAD/FILE NAME		DWG. NO.	
OP Assembly.idw		SCALE	
		1/1	
		CALC.WT	
		N/A	
		SHEET	
		1 OF 2	

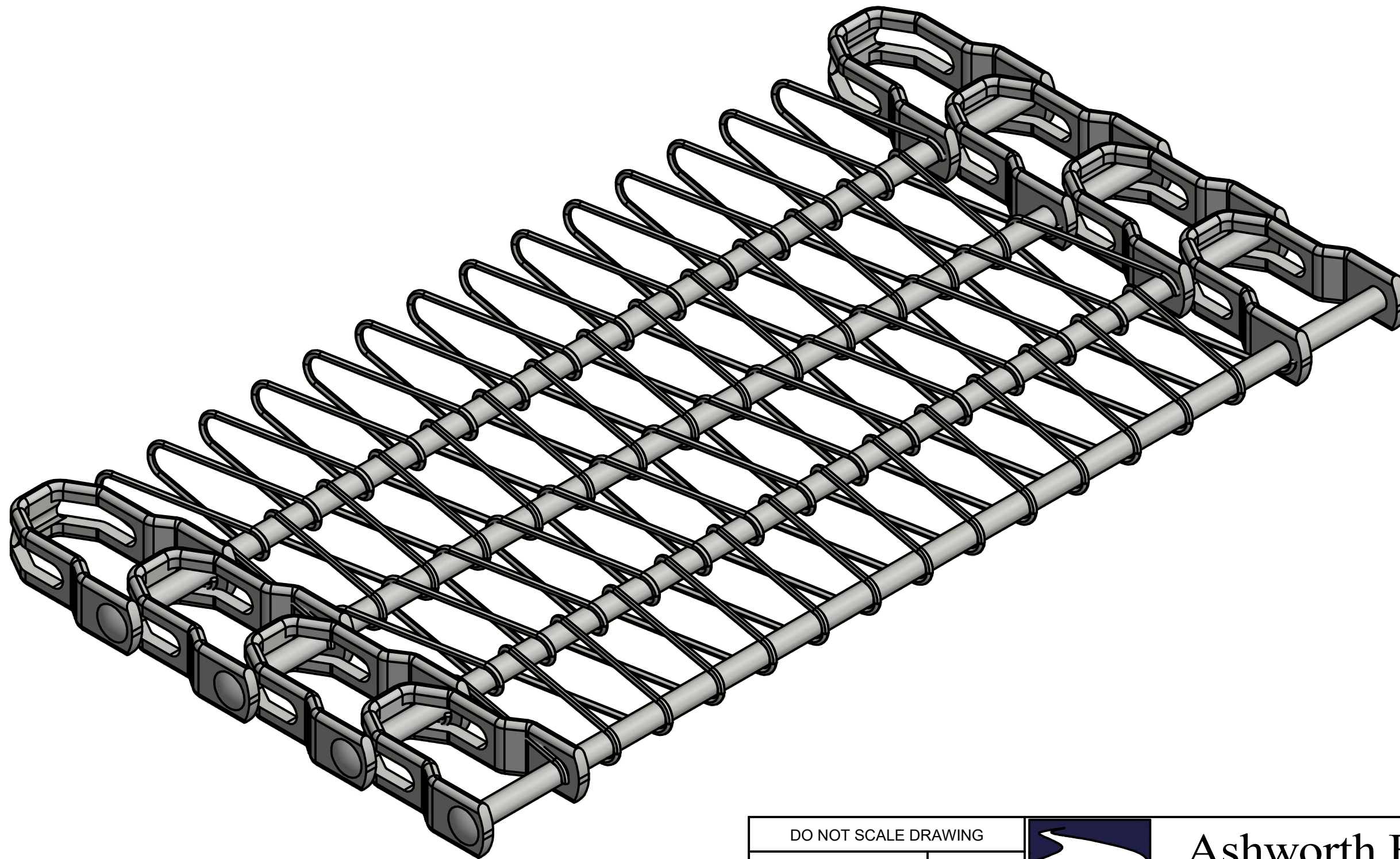

VIEW5
SCALE 1/1

DO NOT SCALE DRAWING		 Ashworth Bros., Inc. 450 ARMOUR DALE, WINCHESTER, VA 22601
APPROVALS	DATE	
DRAWN	7/8/16	TITLE
UNLESS OTHERWISE SPECIFIED DIMENSIONS ARE IN INCHES. TOLERANCES: .X = ± .03 FRACTION ± 1/16 .XX = ± .015 ANGLES ± 1/2° .XXX = ± .005 .XXXX = ± .0005 SURF FINISH 63 ✓		ILLUSTRATION OG360-150 B18-8-16
SIZE	DWG. NO.	REV.
B		
CAD/FILE NAME	SCALE	CALC.WT
OP Assembly.idw	1/1	N/A
	SHEET	
	2 OF 2	